



COXO C-SMART-I PILOT Endo Motors User Manual

Contents

- [1 COXO C-SMART-I PILOT Endo Motors](#)
- [2 User Guide](#)
- [3 Disclaimer](#)
- [4 Safety](#)
- [5 Description of the Product](#)
- [6 Instrument Overview](#)
- [7 Technical Specifications](#)
- [8 Preparation](#)
- [9 Operation](#)
- [10 Documents / Resources](#)
- [11 Related Posts](#)

COXO[®]

COXO C-SMART-I PILOT Endo Motors



User Guide

Requirement

Read these instructions prior to first use in order to avoid misuse and prevent damage. Hazard levels The warning and safety notes in this document must be observed to prevent personal injury and damage to the instrument. The warnings are as follow:

Warning

In cases which – if not prevented – could lead to death or severe injury.

CAUTION:

If not heeded could lead to minor or moderate injury.

NOTE:

In cases which – if not prevented – could cause damage to the instrument.

Target Reader

This document is intended for dentists, dental clinic workers, and service agents.

Repair Service

For repairs, please contact the manufacturer or authorized dealers.

Terms and Conditions of Warranty

Within the scope of the applicable manufacturer delivery and payment conditions, the manufacturer guarantees proper function, absence of defects in the instrument for a period of 24 months from the date of purchase. The date of purchase should be confirmed by the salesperson.

The supplier can provide circuit diagrams, component lists, legends, calibration rules, or other materials necessary for repair by qualified technicians and repairable instrument parts designated by the manufacturer as required.

Disclaimer

Manufacturer will not be responsible for accidents, instrument damage, or bodily injury resulting from:

- Repairs made by personnel not authorized by the manufacturer.
- Any changes, modifications, or alterations of its products.
- The use of any products or instruments made by other manufacturers which are not included as approved by the manufacturer.
- Maintenance or repairs using parts or components other than those specified by the manufacturer and any alterations from original condition of the instrument.
- Operating the instrument in ways other than the operating procedures described in this manual or resulting from the safety precautions and warnings in this manual not being observed.
- Workplace conditions and environment or installation conditions which do not conform to those stated in this manual such as improper electrical power supply.
- Fires, earthquakes, floods, lightning, natural disasters, or any other unforeseeable forces.

In Case of Accident

If an accident occurs, the instrument must not be used until repairs have been completed by a qualified and trained technician authorized by the manufacturer.

User Qualifications

Intended Operator Profile

- Qualification: Legally qualified person such as dentists for endodontic instrument operation (it may differ among countries).
- Education and Knowledge: It is assumed the user is thoroughly familiar with root canal measuring and treatment including the prevention of cross contamination.
- Language Understanding: English (Intended for professional use as described above).
- Experience: Experienced person in operating with an endodontic instrument.
- Locations of use: Dental hospital or dental clinic.

Operation, Transport and Storage Environment

- Operating
 - Temperature: +5°C to +40°C
 - Humidity: 20% to 80%
 - Atmospheric Pressure: 86kPa to 106kPa
- Transport and Storage
 - Temperature: -10°C to +55°C
 - Humidity: ≤ 93% (without condensation)
 - Atmospheric Pressure: 50 kPa to 106 kPa

Disposal of Medical Instruments

In accordance with the principles, standards, and requirements of the country (region) in which A you are located. When disposing of the old electrical instrument ensure that pollution is not produced in the process of waste disposal.

Safety

The instructions for use are a component of the product and must be read carefully prior to use and be accessible at all times. The instrument may only be used in accordance with the intended use; any other type of use is not permitted.

1. Infection Hazard

Patients, users, or third parties could be infected by contaminated medical instruments.

- Take suitable personal protective measures.
- Follow the instructions for using the components.
- Before and after each use, reprocess and sterilize the medical instrument and accessories accordingly.
- Carry out the cleaning and sterilization as described in the instructions for use.
- The procedure has been validated by the manufacturer.
- It is essential to ensure the effectiveness of the cleaning and sterilization in the case of deviation in procedure.
- Prior to disposal, the product and accessories must be appropriately reprocessed or sterilized.

2. Explosion Hazard Area

Electrical sparks in the product can lead to explosion or fire.

- Do not use product in explosive hazardous areas.
- Do not operate the product in an oxygen-enriched environment.
- Do not use the product near the vicinity of flammable gases.

3. Technical Condition

A damaged instrument or components could injure patients, users, and third parties. A damaged power cable or missing protective conductor can lead to electrical shock.

- Only operate instruments or components if they are undamaged on the outside.
- Check the power cable before use.
- Connect only to sockets with a protective contact that meet the respective national regulations.
- Check the proper working order and proper condition of product and accessories before each use.
- Have parts with sites of breakage or surface changes checked by authorized service personnel.
- Safety checks may only be performed by trained service personnel.

4. Ingress of Liquids

Use of the product in moist or electrically conductive environments can lead to electrical shock and injury to patients, users, and third parties.

- Only use the product in dry environments.
- Use the product only in environments that are not electrically conductive.
- Prevent liquid from entering the openings of the product.
- Do not place the product in long or narrow containers.
- If any liquid is detected on the instrument, disconnect the power cable immediately and do not touch the

product.

- Make sure that the surface of the product is absolutely dry before plugging the power cable back into the socket.
- After interventions on and repairs of the instrument and before re-use, have the service personnel perform safety checks on the instrument.

5. Accessories and Combinations with Other Instrument

Use of unauthorized accessories or unauthorized modifications of the instrument could lead to injury.

- Only use accessories that have been approved for combination with the product by the manufacturer.
- Only use accessories that are equipped with standardized interfaces.
- Do not make any modifications to the instrument unless these have been approved by the manufacturer of the product.

6. Electromagnetic Fields

Electromagnetic fields might interfere with the functions of implanted systems (such as pacemakers). Medical electrical instruments are subject to special precautions regarding electromagnetic compatibility and must be installed and operated in accordance with the tables of electromagnetic compatibility. About electromagnetic compatibility refer to 12

High-frequency communications instruments may interfere with medical electrical instruments.

- Ask patients if they have a cardiac pacemaker or other system implanted before you start the treatment.
- Comply with the tables of electromagnetic compatibility during installation and commissioning.
- If the instrument needs to be used in the immediate vicinity of another instrument, monitor the instrument or system for malfunctions.

7. Contra-angle

- Only use the original contra-angle.
- Never press the contra-angle push button when handpiece is running. It will cause the file to fall off.
- Never remove the contra-angle during operation.
- Only use undamaged root canal instruments, refer to 7.
- Never place your fingers on the moving parts of the instrument while it is running.
- Before use, check the contra-angle for any damage or loose part.

8. Root canal instruments

- Never use continuous rotary instruments in reciprocating mode.
- Never use reciprocating instruments in rotary mode.
- Refer to the file manufacturer's instructions to adjust the speed and torque.

Description of the Product

Endo Motor products are mainly used in dental root canal preparation is used for each model pulpitis and pulp necrosis and various root canal treatment of important instrument.

1. Intended Use

The Endo Motors device is a endodontic treatment motorized handpiece with root canal measurement capability. It can be used to enlarge the canals while monitoring the position of the file tip inside the canal. The instrument must only be used in hospital environments, clinics or dental offices, by qualified practitioners.

2. Contraindications

- In cases where a patient has been fitted with an implanted heart pacemaker (or other electrical

equipment) and has been cautioned against the use of small electrical appliances (such as electric shavers, hair dryers, etc) it is recommended not to use the instrument.

- Safety and effectiveness have not been established in pregnant women and children.
- Clinical judgment needs to be applied by the end user of the device.

Instrument Overview

1. Components and Accessories



Control Unit



Motor Handpiece



Contra-angle



File Clip



Root apex test wire



Lip Hook wire

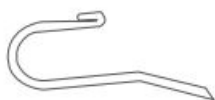

Lip Hook



Tester

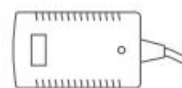

Adaptor

CAUTION:

If the accessories of this product are damaged, please purchase original accessories and replace and use them according to the instructions.

2. Control Unit

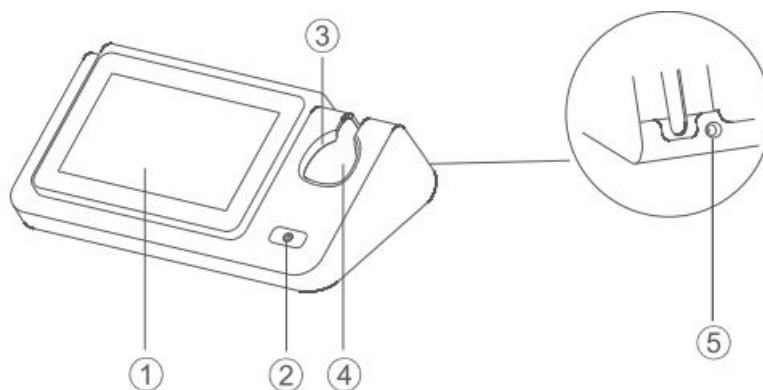

1. Touch Screen
2. ON/OFF Button
3. Handpiece Charger
4. Power Supply Jack

Handpiece

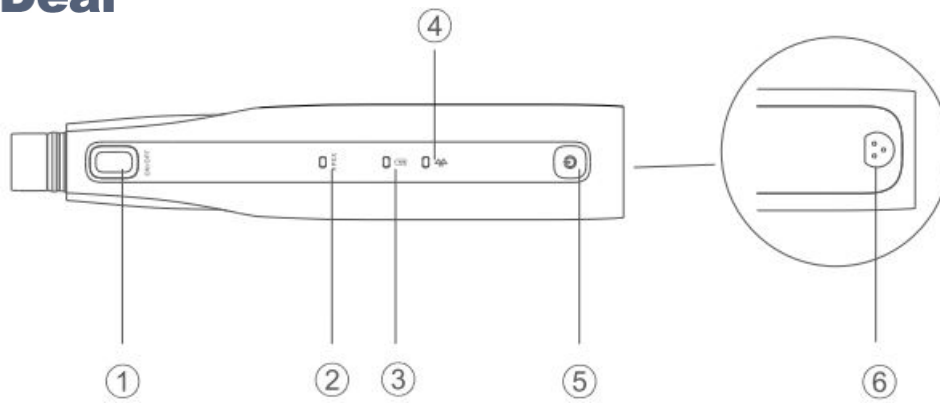

1. ON/OFF Button
2. Apex Locator Indicator
3. Battery Indicator
4. Bluetooth Indicator
5. Power button
6. Lip hook wire jack /Root apex test wire /Tester jack

Contra-Angle

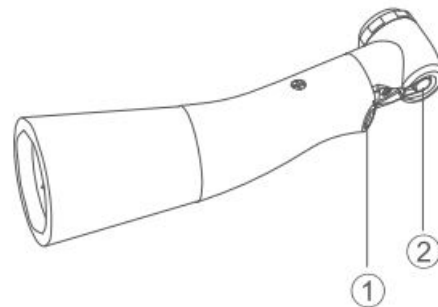

1. Handpiece Light
2. Built-in Electrode

Technical Specifications

AC adapter	Input: AC100-240V Output: DC10V 1.5A
	Frequency : 50/60Hz
Control unit's battery	Lithium ion battery (DC7.4V)
Handpiece's battery	Lithium ion battery (DC 3.7V)
LED	3.3V
Speed	150-1000rpm
Torque	0.6-3.9Ncm
Protection against Electric Shock	Type B applied part
Classification of Protection against Electric Shock	Class II (adapter)
Control unit's input power	35VA
Operation	Short time
Gear ratio	1.9:1
File of contra-angle	ISO1797-1Type1 diameter:2.35mm,minmum fitting length:11mm.overall length:max23mm,working diameter: max 2 mm
File of file clip	File of Root Apex Locators meet the ISO 3630-1 Type 1 Neckdiameter(d16): min 0.52mm, max 1.72mm Head diameter (D): min 0.20mm, max 1.40mm Working length (116): 16mm
Applied part	Contra-angle, File clip, Lip hook.
Measurement accuracy	±0.5mm
Degree of Protection(IEC 60529)	IPX0

Preparation

First charge

Prior to first use, you need to charge the control unit and handpiece.

- Put handpiece in handpiece charger.
- Insert adapter and connect main power supply to charge control unit and handpiece

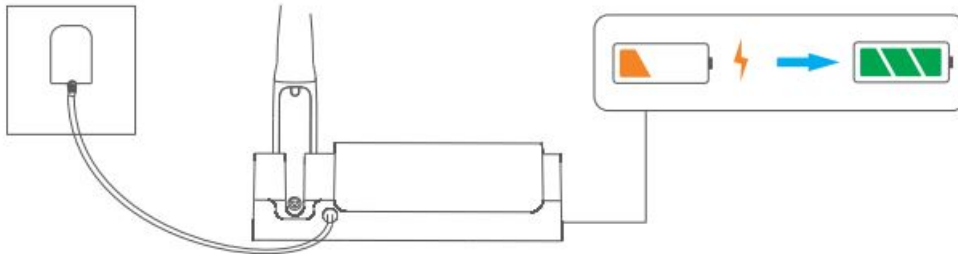

- When control unit charging, the screen displays the charging symbol and status. After 1 minute of inactivity, the symbol will disappear. You can press the ON/OFF button or touch the screen to check the charging status.

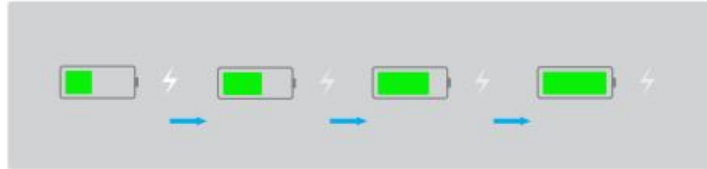

- When handpiece charging, charging light (orange) on the control unit flashes and the light (green) will stay on when fully charged.

Note:

- The first charge will take more than 4 hours.
- For the battery and charging, please refer to 6.

Power On/Off

1. Control Unit

Press  to turn on, long press to turn off.

2. Handpiece

Press  to turn on, long press to turn off

General Setting

Press  to enter setup state.

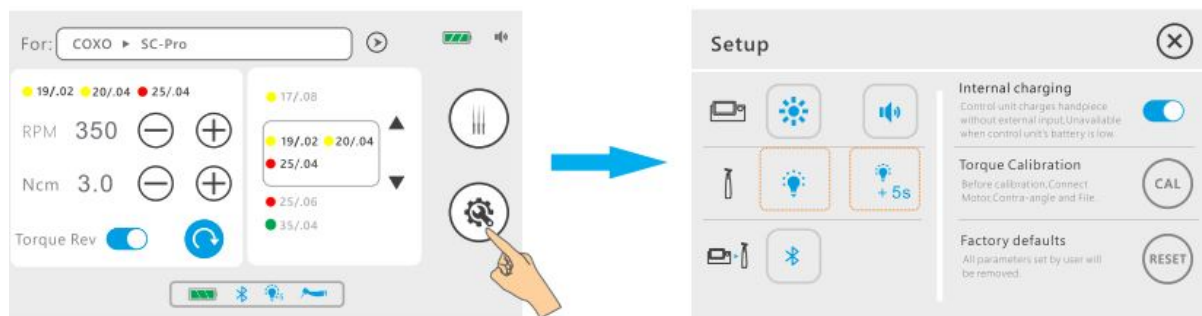

Screen brightness: Press  to change screen brightness status as below.



Button sound: Press  /  to switch on/off button sound.

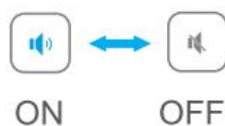

NOTE:

The change will be automatically saved.



Activating Bluetooth

Connect hand piece to control unit via Bluetooth.



1. Connecting

Default Bluetooth is connected. Bluetooth will automatically connect when control unit and handpiece are turned on.

2. Pairing

- Press  to enter setup state and then press  to pair Bluetooth;



Press  and  at the same time, until Bluetooth LED solid.

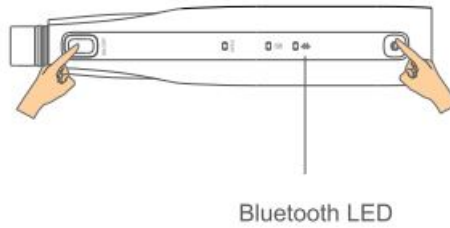



During Bluetooth pairing, the icon changes as shown in below :



NOTE:

- Priro to the Bluetooth connection, the Bluetooth indicator (blue) on the handpiece is flashing. When paired, the indicator is on.
- The Bluetooth connection will be saved automatically.
- Bluetooth pairing is only required after replacing control unit or handpiece.

3. Disconnecting

Press  to enter setup state and then press  to prepare to disconnect;
Follow the prompt step by step.

Operation

The instrument integrates three modes namely.

Endo motor mode: root canal preparation.

Apex locator mode: root canal length measurement.

Multi-function mode: undertake root canal measurement and preparation.

1. Endo Motor Mode

If not any test wire connected to the instrument, it automatically enters Endo Motor Mode.

1. Connection Accessories

- Connect contra-angle

Align and connect the locating slot and the locating pin.

Disconnecting: Pull it straight out.

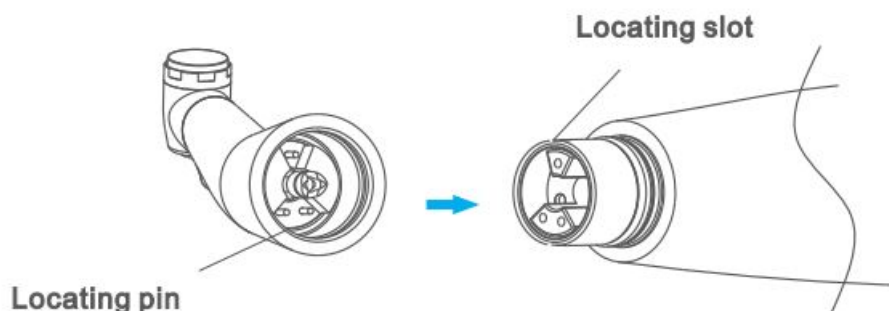

2. Connect File

- Hold down the push button on the contra-angle and insert the file
- Pull on the file gently to make sure it is locked.

Disconnecting: Press the push button and pull out the file.

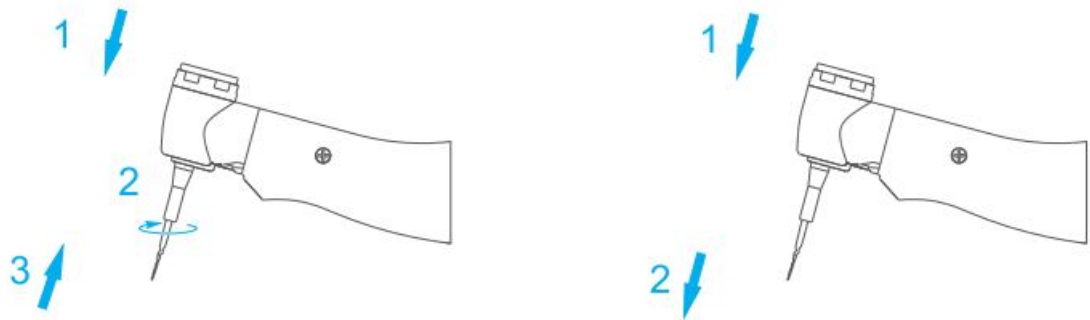

WARNING:







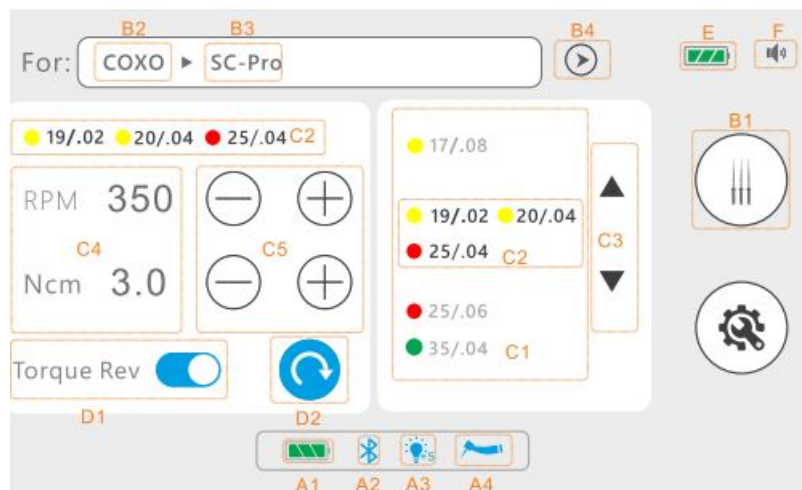

- Make sure the connection is not damaged.
- Never use stretched, deformed or damaged files.

CUTION:

- Be careful when inserting and removing files to avoid injury.
- Inserting and removing files without holding the push button may damage the chuck.
- Gently drag the file to confirm that it is locked

2. Interface Overview



A	A1		Handpiece power, refer to 6
	A2		Bluetooth, refer to 4.4
	A3		Handpiece LED light, refer to 5.1.4
	A4		Endo motor function
B	B1		NITI system, refer to 5.1.3
	B2	COXO	File manufacturer, refer to 5.1.3
	B3	SC-Pro	NITI system name, refer to 5.1.3
	B4		Select different NITI system, refer to 5.1.3
C	C1	<ul style="list-style-type: none"> ● 17/.08 ● 19/.02 ● 20/.04 ● 25/.04 ● 25/.06 ● 35/.04 	Files in the NITI system, refer to 5.1.3
	C2	<ul style="list-style-type: none"> ● 19/.02 ● 20/.04 ● 25/.04 	Currently selected File(s) , refer to 5.1.3
	C3	<ul style="list-style-type: none"> ▲ ▼ 	Up/down, File select button, refer to 5.1.3
	C4	Rpm 350 Ncm 3.0	Motor Speed and Torque, refer to 5.1.9
	C5		Increase/ decrease button, adjust speed or torque ,refer to 5.1.9
D	D1	Torque Rev 	On/off Torque Reverses refer to 5.1.5